



SOME SEE JUST A CABLE

VI SEE A CONNECTED WORLD

MARINE LADDERS

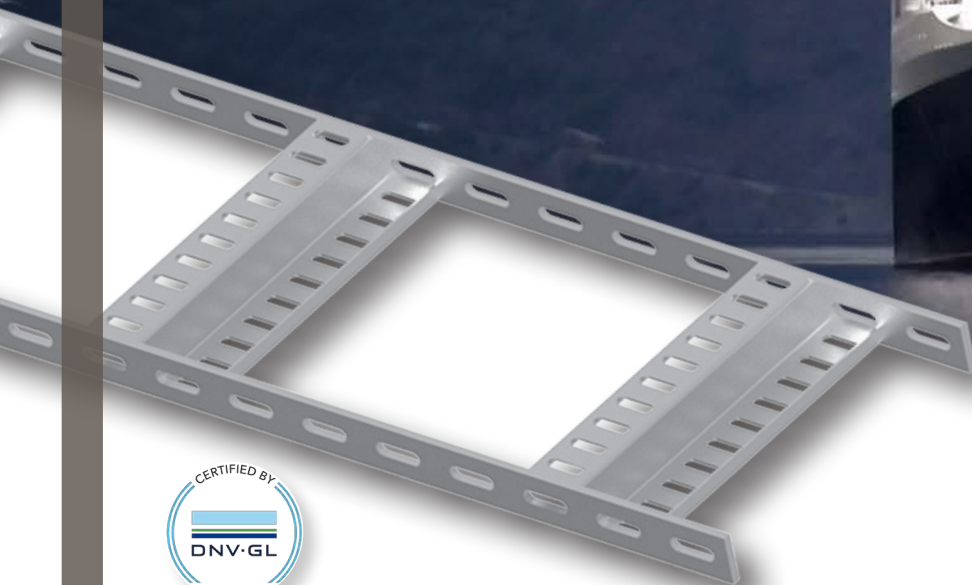



TABLE OF CONTENT

This product catalogue contains technical information about our wide range of marine ladders.

In combination with our wide range of marine cables, we are the preferred partner for many companies in the industry.

We deliver daily for small as well as large projects within newbuildings as well as for renovation / updating of ships, drilling platforms or port projects.

If you are searching for information about wire mesh trays, cable trays and cable ladders and related accessories, please refer to our additional product catalogues.

Contact us for more information on +45 6343 1545 or visit our webpage at www.scankabsystems.com

MARINE LADDERS

H30	4
H30 - Z-step	5
H40 - Z-step	6

CONNECTOR + ASSEMBLY PARTS

H30	8
H40	8
Assembly parts	8

FIXING CLAMPS

H30	9
H40	9

HORIZONTAL BENDS

H30	10
H30 - Z-step	10
H40 - Z-step	11

VERTICAL BENDS

H30	12
-----	----

ADD-ON TEE

H30	14
H30 - Z-step	14
H40 - Z-step	15

MARINE LADDERS

Marine ladder - single step (H: 30 mm, L: 3000 m)
Material thickness: 5 mm

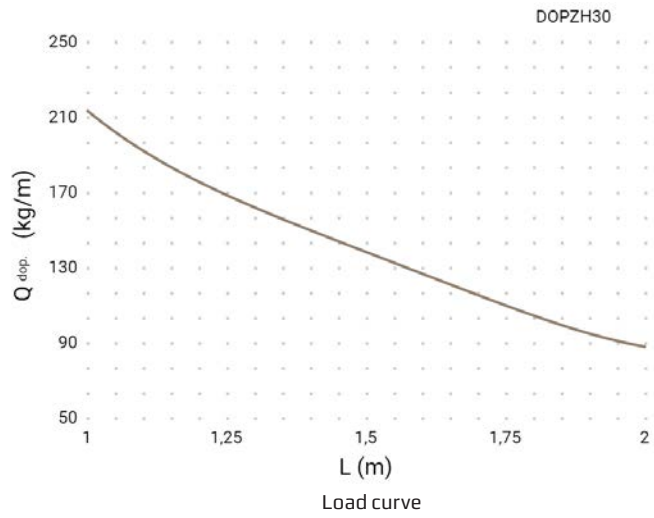
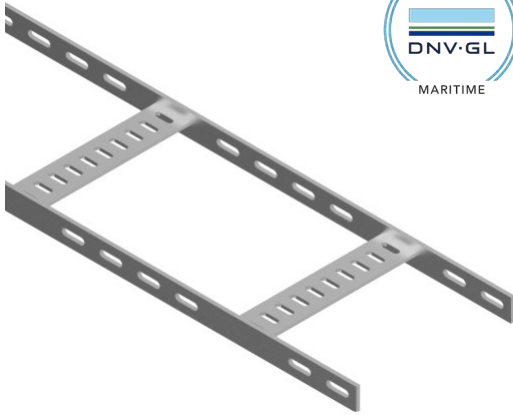

SKU	Product	Material	Width mm	Weight kg / m
Hot-dip galvanized, coating thickness 45-55 µm. Corrosion class C1 - C4				
0723130100	100x30x5 mm marine ladder single	HDG	110	2,70
0723130200	200x30x5 mm marine ladder single	HDG	210	3,05
0723130300	300x30x5 mm marine ladder single	HDG	310	3,41
0723130400	400x30x5 mm marine ladder single	HDG	410	4,55
Stainless steel A4 can be delivered on request				

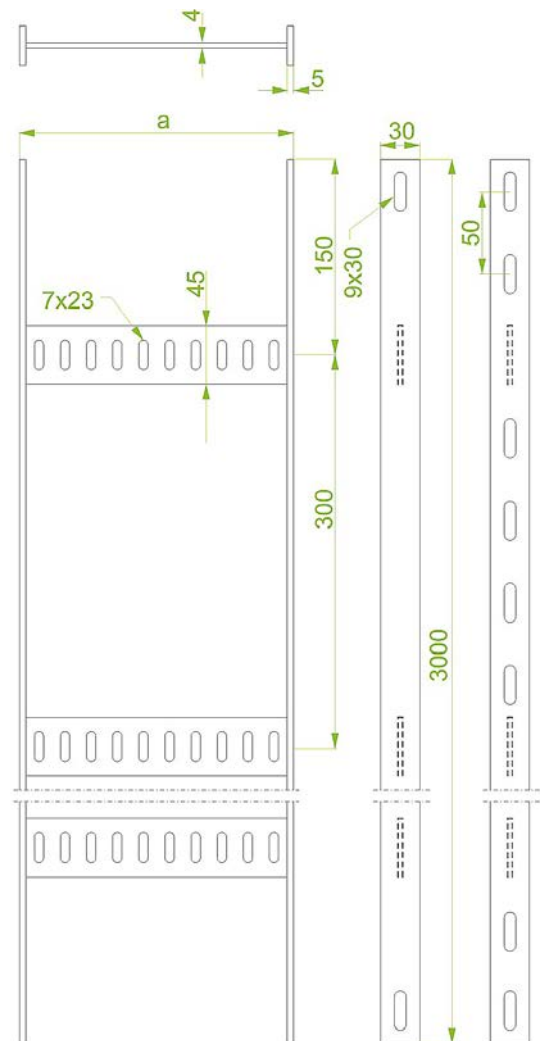

All dimensions are stated in mm.

MARINE LADDERS

Marine ladder - Z-step (H: 30 mm, L: 3000 mm)
Material thickness: 3 mm

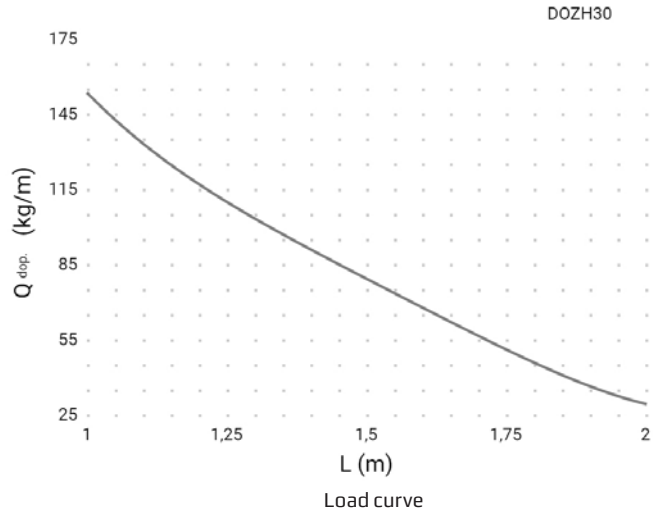
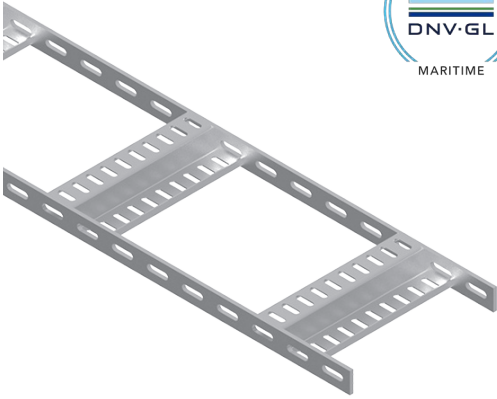

SKU	Product	Material	Width mm	Weight kg / m
Hot-dip galvanized, coating thickness 45-55 µm. Corrosion class C1 - C4				
0723230100	100x30x3 mm marine ladder Z	HDG	106	1,68
0723230200	200x30x3 mm marine ladder Z	HDG	206	2,17
0723230300	300x30x3 mm marine ladder Z	HDG	306	2,67
0723230400	400x30x3 mm marine ladder Z	HDG	406	3,18
0723230500	500x30x3 mm marine ladder Z	HDG	506	3,69
0723230600	600x30x3 mm marine ladder Z	HDG	606	4,17
0723230700	700x30x3 mm marine ladder Z	HDG	706	4,74
0723230800	800x30x3 mm marine ladder Z	HDG	806	5,25
0723230900	900x30x3 mm marine ladder Z	HDG	906	5,76
0723230999	1000x30x3 mm marine ladder Z	HDG	1006	6,21
Stainless steel A4 can be delivered on request				

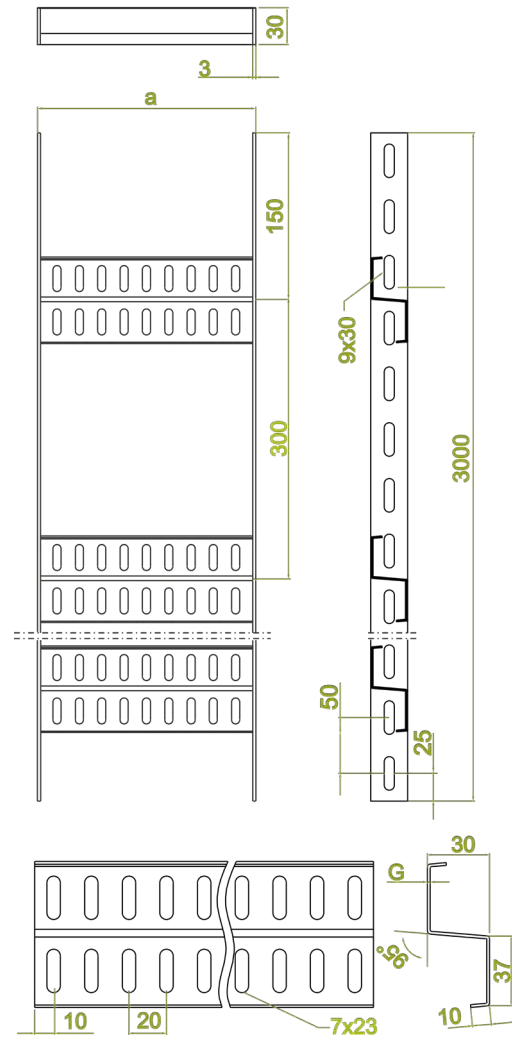

All dimensions are stated in mm.

MARINE LADDERS

Marine ladder Z-step (H: 40 mm, L: 3000 mm)
Material thickness: 4 mm

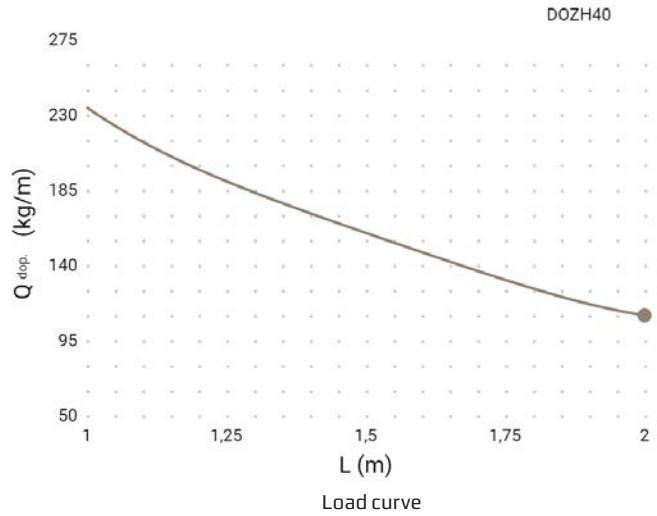
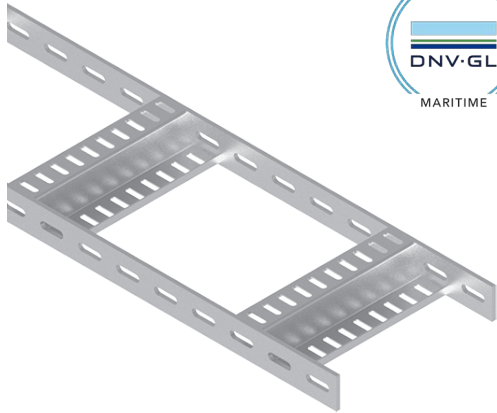

SKU	Product	Material	Width mm	Weight kg / m
Hot-dip galvanized, coating thickness 45-55 µm. Corrosion class C1 - C4				
0723240100	100x40x4 mm marine ladder Z	HDG	106	3,20
0723240150	150x40x4 mm marine ladder Z	HDG	156	3,47
0723240200	200x40x4 mm marine ladder Z	HDG	206	3,74
0723240250	250x40x4 mm marine ladder Z	HDG	256	4,01
0723240300	300x40x4 mm marine ladder Z	HDG	306	4,28
0723240350	350x40x4 mm marine ladder Z	HDG	356	4,55
0723240400	400x40x4 mm marine ladder Z	HDG	406	4,82
0723240500	500x40x4 mm marine ladder Z	HDG	506	5,36
0723240600	600x40x4 mm marine ladder Z	HDG	606	6,05
0723240700	700x40x4 mm marine ladder Z	HDG	706	6,68
0723240800	800x40x4 mm marine ladder Z	HDG	806	7,40
0723240900	900x40x4 mm marine ladder Z	HDG	906	8,00
0723240999	1000x40x4 mm marine ladder Z	HDG	1006	8,60
Other dimensions are available on request				

SKU	Product	Material	Width mm	Weight kg / m
Stainless S5316 A4.				
0726240100	100x40x4mm Marine ladder Z	S5316 A4	106	3,20
0726240150	150x40x4mm Marine ladder Z	S5316 A4	156	3,47
0726240200	200x40x4mm Marine ladder Z	S5316 A4	206	3,74
0726240250	250x40x4mm Marine ladder Z	S5316 A4	256	4,01
0726240300	300x40x4mm Marine ladder Z	S5316 A4	306	4,28
0726240400	400x40x4mm Marine ladder Z	S5316 A4	356	4,55
Other dimensions are available on request				

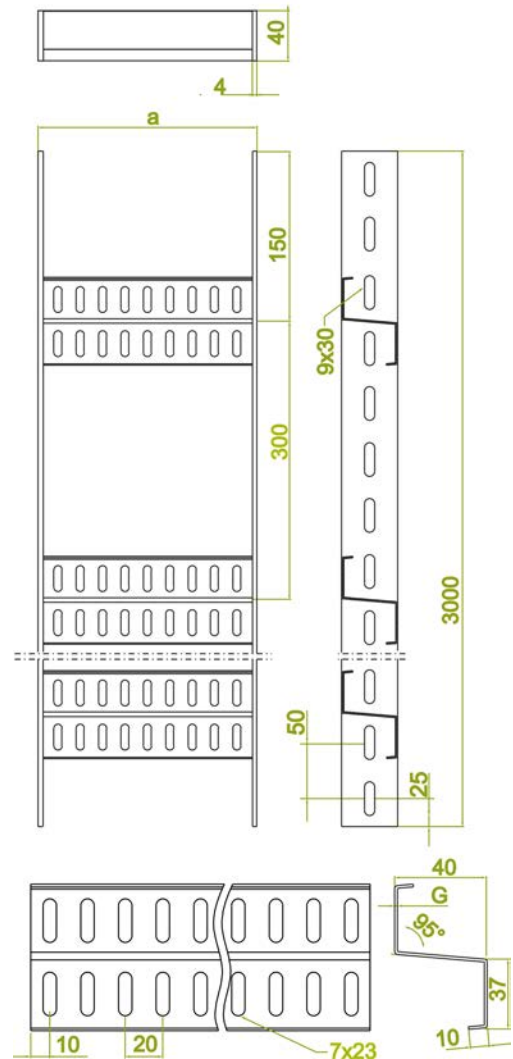

All dimensions are stated in mm.



SOME SEE JUST A CABLE

VI SEE DELIVERIES THROUGH FIRE AND WATER

"The particularly stringent requirements made of products used in the marine and off-shore industries confirm that the market requires products of high quality paired with the wish for technical and professional sparring. In this aspect, Scankab is able to make an important contribution and ensure that the right products are available."

” Morten Rasmussen,
CEO, Scankab

Connector

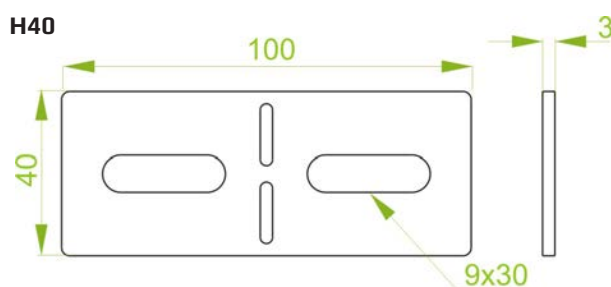
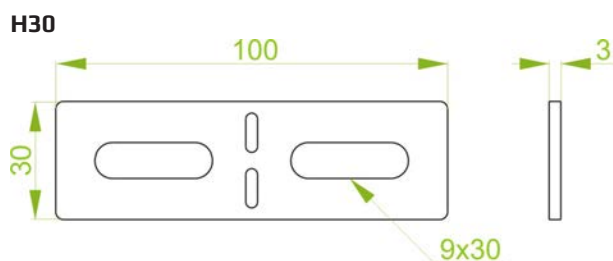

All dimensions are stated in mm.

SKU	Product	Height mm	Material
Hot-dip galvanized, coating thickness 45-55 μm . Corrosion class C1 - C4			
0823500030	30 mm lige Connector marine	30	HDG
0823500040	40 mm lige Connector marine	40	HDG

SKU	Product	Height mm	Material
Stainless S5316 A4.			
0826500030	30 mm lige Connector marine	30	A4
0826500040	40 mm lige Connector marine	40	A4

Assembly parts

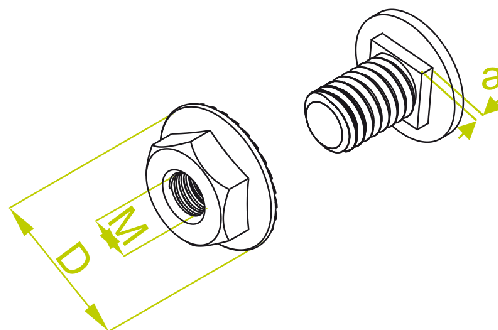

All dimensions are stated in mm.

SKU	Product	Størrelse M mm	Længde L mm	Diameter mm	Material	Quantity
Varmgalvaniseret efter bearbejdning, belægningstykkelse 45-55 μm . Korrosionsklasse C1 - C4 Stainless S5316 A4						
0823501041	8x16 mm bolt set marine	8	16	17	HDG	100 pcs.
0826501041	8x16 mm bolt set marine	8	16	17	A4	100 pcs.

FIXING CLAMP

Fixing clamp

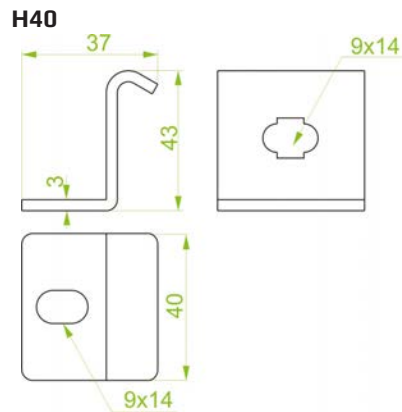
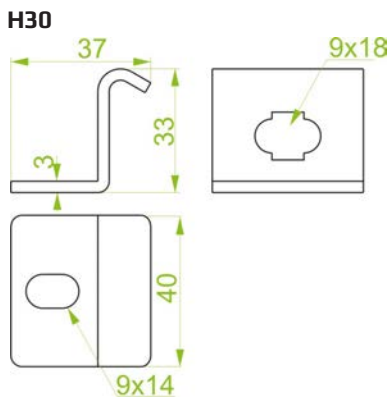

All dimensions are stated in mm.

SKU	Product	Height mm	Material
Hot-dip galvanized, coating thickness 45-55 µm. Corrosion class C1 - C4			
0823501030	30 mm Fixing clamp marine	30	HDG
0823501040	40 mm Fixing clamp marine	40	HDG

SKU	Product	Height mm	Material
Stainless 5S316 A4.			
0826501030	30 mm Fixing clamp marine	30	A4
0826501040	40 mm Fixing clamp marine	40	A4

HORIZONTAL BENDS

90° bend - single step (H30)

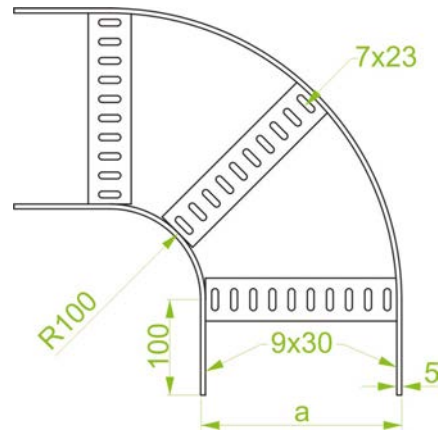
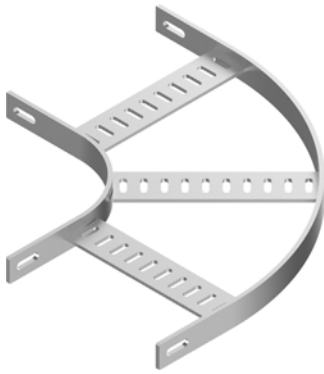

All dimensions are stated in mm.

SKU	Product	Material	Width mm	Weight kg / m
Hot-dip galvanized, coating thickness 45-55 µm. Corrosion class C1 - C4				
0823501131	100x30 mm marine bend	HDG	110	1,37
0823501231	200x30 mm marine bend	HDG	210	1,93
0823501331	300x30 mm marine bend	HDG	310	2,49
Stainless SS316 A4 can be delivered on request				

90° bend - Z-step (H30)

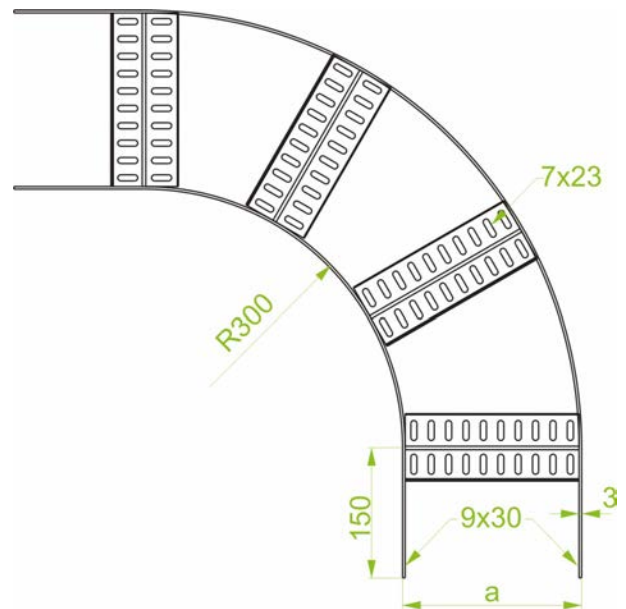

All dimensions are stated in mm.

SKU	Product	Material	Width mm	Weight kg / m
Hot-dip galvanized, coating thickness 45-55 µm. Corrosion class C1 - C4				
0823501132	100x30 mm marine bend Z	HDG	106	1,88
0823501232	200x30 mm marine bend Z	HDG	206	2,63
0823501332	300x30 mm marine bend Z	HDG	306	3,42
0823501432	400x30 mm marine bend Z	HDG	406	4,21
0823501532	500x30 mm marine bend Z	HDG	506	5,84
0823501632	600x30 mm marine bend Z	HDG	606	6,75
0823501732	700x30 mm marine bend Z	HDG	706	7,81
0823501832	800x30 mm marine bend Z	HDG	806	8,77
0823501932	900x30 mm marine bend Z	HDG	906	9,73
0823501933	1000x30 mm marine bend Z	HDG	1006	10,59
Stainless SS316 A4 can be delivered on request				

HORIZONTAL BENDS

90° bend - Z-step (H40)

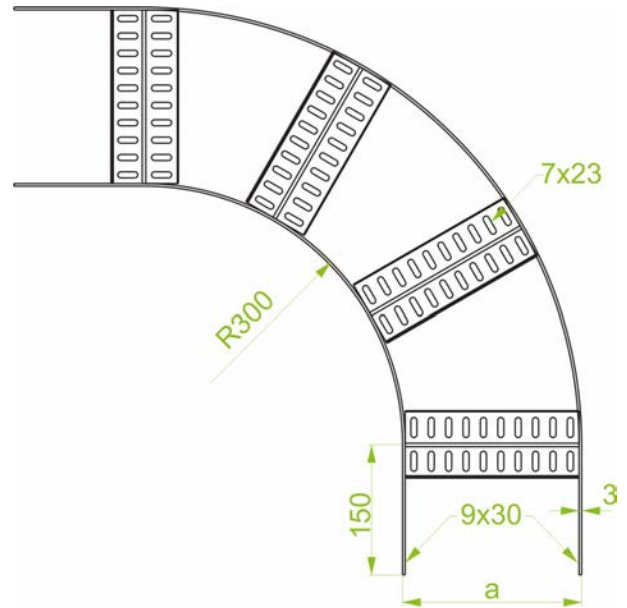

All dimensions are stated in mm.

SKU	Product	Material	Width mm	Weight kg / m
Hot-dip galvanized, coating thickness 45-55 µm. Corrosion class C1 - C4				
0823501142	100x40 mm marine bend Z	HDG	110	3,46
0823501242	200x40 mm marine bend Z	HDG	210	4,46
0823501342	300x40 mm marine bend Z	HDG	310	5,40
0823501442	400x40 mm marine bend Z	HDG	410	6,36
0823501542	500x40 mm marine bend Z	HDG	510	8,23
0823501642	600x40 mm marine bend Z	HDG	610	9,61
0823501742	700x40 mm marine bend Z	HDG	710	11,10
0823501842	800x40 mm marine bend Z	HDG	810	12,36
0823501942	900x40 mm marine bend Z	HDG	910	12,62
0823501943	1000x40 mm marine bend Z	HDG	1010	14,88
Stainless S5316 A4 can be delivered on request				

VERTICAL BENDS

Vertical inner bend - single step (H30)

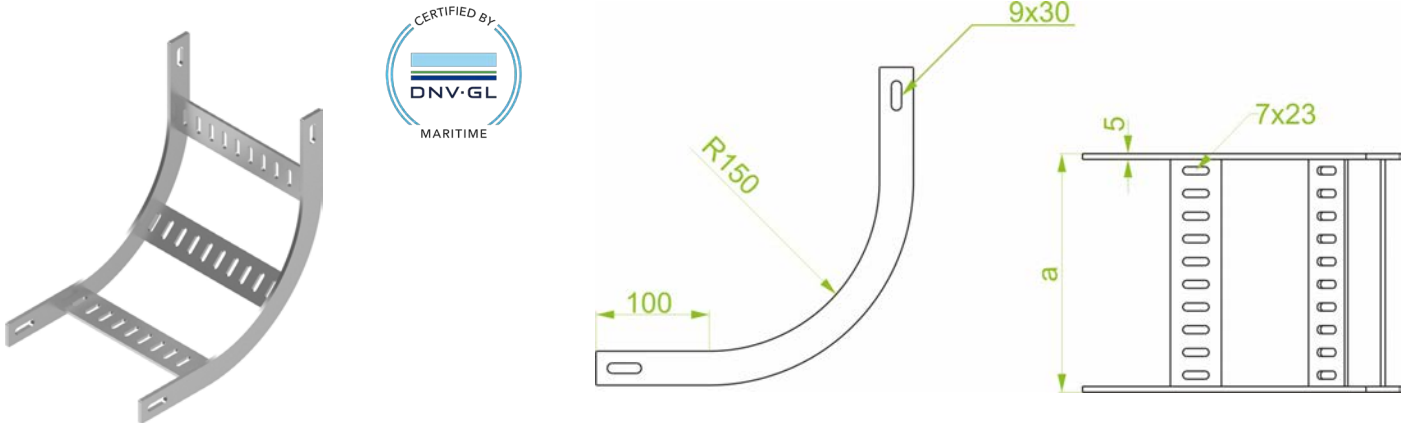

SKU	Product	Material	Width mm	Weight kg / m
Hot-dip galvanized, coating thickness 45-55 µm. Corrosion class C1 - C4				
0823502130	100x30 mm vertical bend	HDG	110	1,42
0823502230	200x30 mm vertical bend	HDG	210	1,78
0823502330	300x30 mm vertical bend	HDG	310	2,14
Stainless SS316 A4 can be delivered on request				

All dimensions are stated in mm.



SOME SEE JUST A CABLE

WE SEE
ENDLESS
POSSIBILITIES

WHY CHOOSE SCANKAB?

- Full-line supplier of cables and cable management
- Day to day shipment / high security of supply
- Own production and development
- Cut in customer-specified lengths
- Special packaging
- Customer-specific products kept in stock
- Personal service



+45 6343 1545

We believe in direct communication

ADD-ON TEE

Add-on Tee - single step (H30)

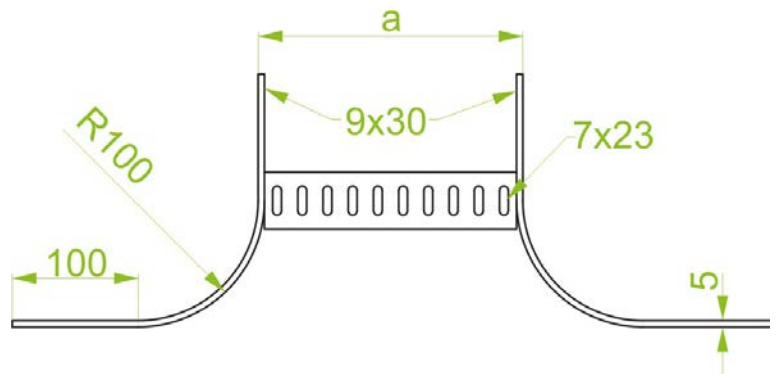

SKU	Product	Material	Width mm	Weight kg / m
Hot-dip galvanized, coating thickness 45-55 µm. Corrosion class C1 - C4				
0823503130	100x30 mm Add-on Tee	HDG	110	0,94
0823503230	200x30 mm Add-on Tee	HDG	210	1,06
0823503330	300x30 mm Add-on Tee	HDG	310	1,18
Stainless S5316 A4 can be delivered on request				

Add-on Tee - Z-step (H30)

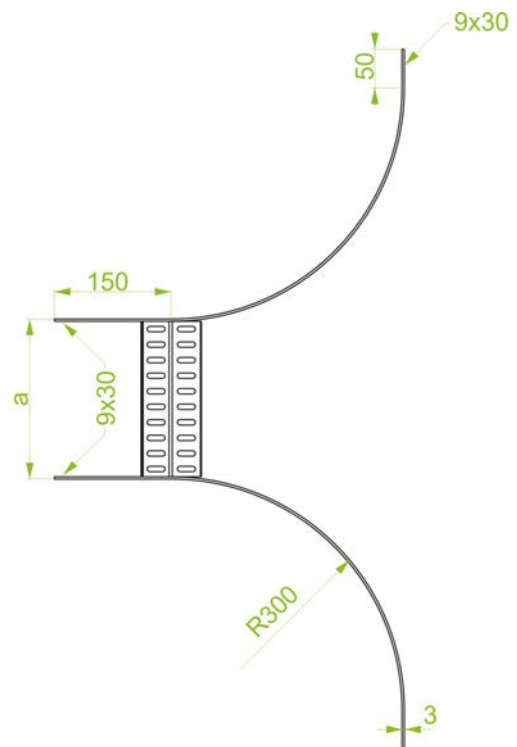
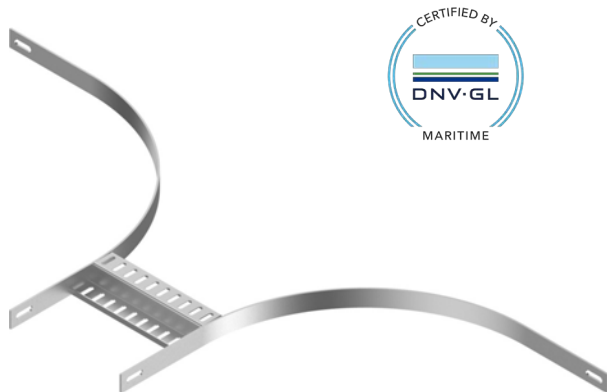

SKU	Product	Material	Width mm	Weight kg / m
Hot-dip galvanized, coating thickness 45-55 µm. Corrosion class C1 - C4				
0823504130	100x30 mm Add-on Tee Z	HDG	106	1,25
0823504230	200x30 mm Add-on Tee Z	HDG	206	1,41
0823504330	300x30 mm Add-on Tee Z	HDG	306	1,58
0823504430	400x30 mm Add-on Tee Z	HDG	406	1,75
0823504530	500x30 mm Add-on Tee Z	HDG	506	1,92
0823504630	600x30 mm Add-on Tee Z	HDG	606	2,08
0823504730	700x30 mm Add-on Tee Z	HDG	706	2,27
0823504830	800x30 mm Add-on Tee Z	HDG	806	2,44
0823504930	900x30 mm Add-on Tee Z	HDG	906	2,61
0823504931	1000x30 mm Add-on Tee Z	HDG	1006	2,76
Stainless S5316 A4 can be delivered on request				

ADD-ON TEE

Add-on Tee - Z-step (H40)

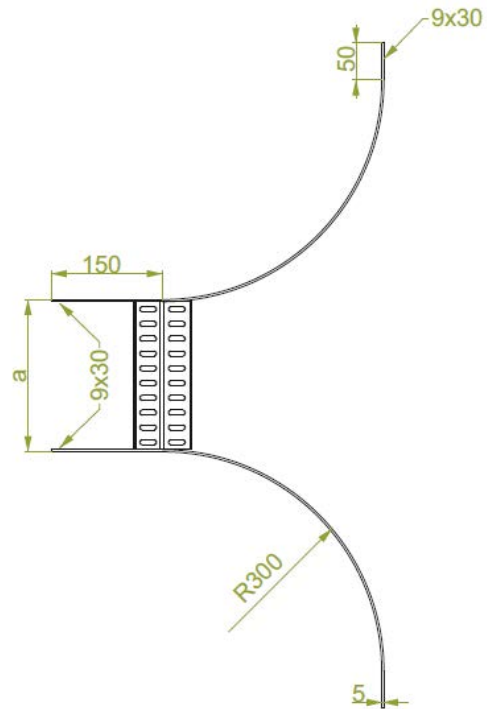

SKU	Product	Material	Width mm	Weight kg / m
Hot-dip galvanized, coating thickness 45-55 µm. Corrosion class C1 - C4				
0823505130	100x40 mm Add-on Tee Z	HDG	110	2,66
0823505230	200x40 mm Add-on Tee Z	HDG	210	2,78
0823505330	300x40 mm Add-on Tee Z	HDG	310	2,96
0823505430	400x40 mm Add-on Tee Z	HDG	410	3,14
0823505530	500x40 mm Add-on Tee Z	HDG	510	3,32
0823505630	600x40 mm Add-on Tee Z	HDG	610	3,55
0823505730	700x40 mm Add-on Tee Z	HDG	710	3,80
0823505830	800x40 mm Add-on Tee Z	HDG	810	4,00
0823505930	900x40 mm Add-on Tee Z	HDG	910	4,20
0823505931	1000x40 mm Add-on Tee Z	HDG	1010	4,40
Stainless S5316 A4 can be delivered on request				



Scankab set out as the cable industry's answer to "garage rock"

From the outset in 1992, Scankab was the rebel of the cable industry. The business sold cables from a small garage store room and challenged the cable market. Today, it is still part of the company's DNA to set new standards for the industry.

Scankab develops, manufactures and supplies quality cables and cable management to electrical contractors, industry, marine & offshore, infrastructure and energy. The range includes more than 3500 stocked cable types. Scankab has its head office and warehouse in Aarup in Funen and its subsidiaries in Norway and Sweden.



**We believe in
direct communication**

Denmark

Tlf. +45 6343 1545

www.scankabsystems.dk

Sweden

Tlf. +46 730-344 606

www.scankabsystems.se

