

rejiband®

35 60 100

Bandeja de rejilla

Wire mesh tray

Chemins de Câbles

☒ 35, 60, 100 • ☒ 60-600 • ☒ 3000

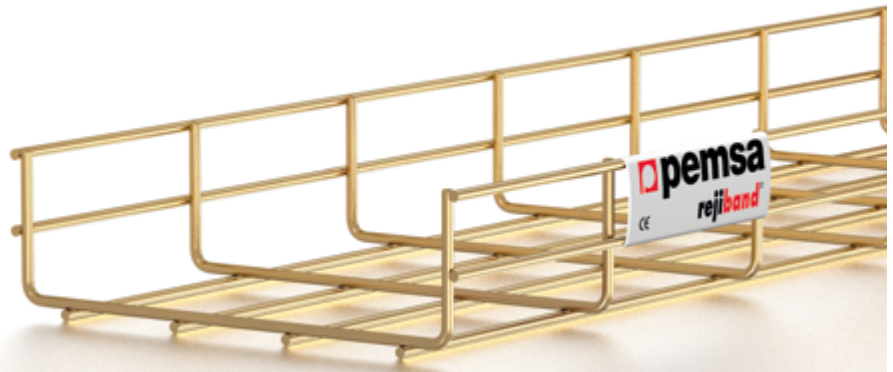

☒	☒	EZ	BC	GC	304	306L	EP	C8	kg/m	☒ u
35	60	60211060	60221060	60231060	60251060	60261060	..	60281060 ☒	0,405	24
	100	60211100	60221100	60231100	60251100	60261100	..	60281100 ☒	0,547	24
	150	60211150	60221150	60231150	60251150	60261150	..	60281150 ☒	0,723	24
	200	60211200	60221200	60231200	60251200	60261200	..	60281200 ☒	1,034	18
	300	60211300	60221300	60231300	60251300	60261300	..	60281300 ☒	1,401	18
	400	60211400	60221400	60231400	60251400	60261400	..	60281400 ☒	1,797	12
60	60	60212060	60222060	60232060	60252060	60262060	60242060	60282060	0,564	24
	100	60212100	60222100	60232100	60252100	60262100	60242100	60282100	0,799	24
	150	60212150	60222150	60232150	60252150	60262150	60242150	60282150	1,022	24
	200	60212200	60222200	60232200	60252200	60262200	60242200	60282200	1,326	18
	300	60212300	60222300	60232300	60252300	60262300	60242300	60282300	2,091	12
	400	60212400	60222400	60232400	60252400	60262400	60242400	60282400	2,565	6
	450	60212450	60222450	60282450	2,642	6
	500	60212500	60222500	60232500	60252500	60262500	60242500	60282500	3,014	6
100	100	60213100	60223100	60233100	60253100	60263100	..	60283100 ☒	1,316	12
	150	60213150	60223150	60233150	60253150	60263150	..	60283150 ☒	1,383	6
	200	60213200	60223200	60233200	60253200	60263200	..	60283200 ☒	2,055	6
	300	60213300	60223300	60233300	60253300	60263300	..	60283300 ☒	2,512	6
	400	60213400	60223400	60233400	60253400	60263400	..	60283400 ☒	2,962	6
	500	60213500	60223500	60233500	60253500	60263500	..	60283500 ☒	3,413	6
rejiband® 		64010061	64020061	64030061	64060061	64060061	64060061	64080061		☒ ☒ 024

☒ Bajo pedido / On request / A la demande

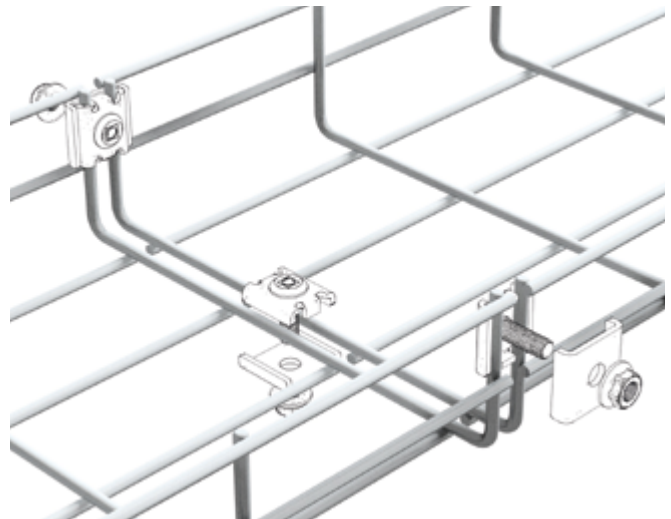
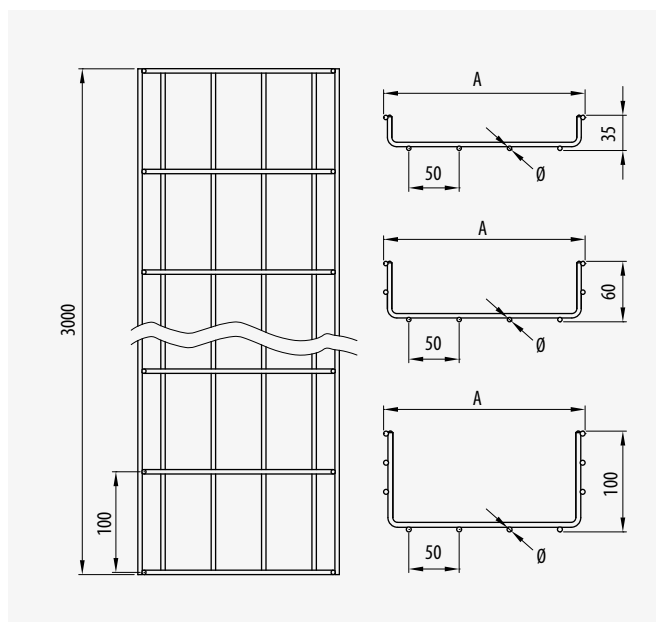



cod. CYWV: E305934



⊕	⊖	mm ²	∅ EZ, BC, GC, EP, C8	∅ 304, 316L
35	60	1.215	4,0	4,0
	100	2.295	4,0	4,0
	150	3.432	4,5	4,5
	200	4.524	4,5	4,5
	300	7.358	4,5	4,5
	400	9.958	4,5	4,5

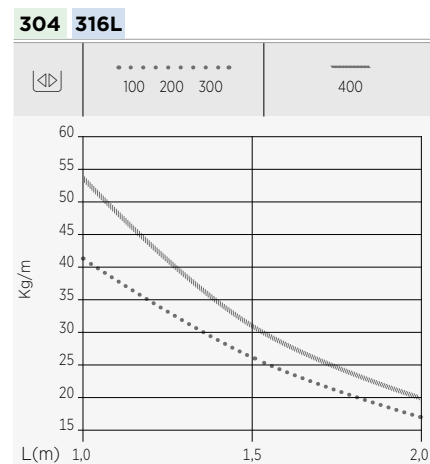
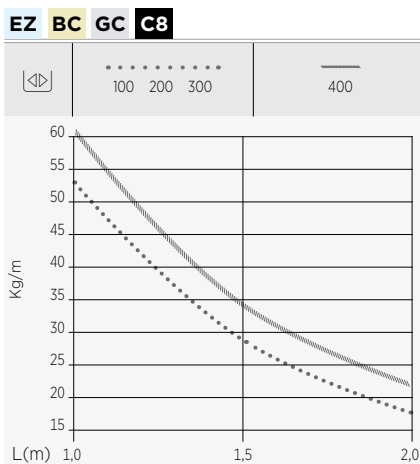

⊕	⊖	mm ²	∅ EZ, BC, GC, EP, C8	∅ 304, 316L
60	60	2.520	4,0	4,0
	100	4.420	4,0	4,0
	150	6.783	4,5	4,5
	200	9.333	4,5	4,5
	300	14.050	5,0	4,5
	400	19.050	5,0	4,5
	450	21.500	5,0	..
	500	24.050	5,0	4,5
	600	29.050	5,0	4,5

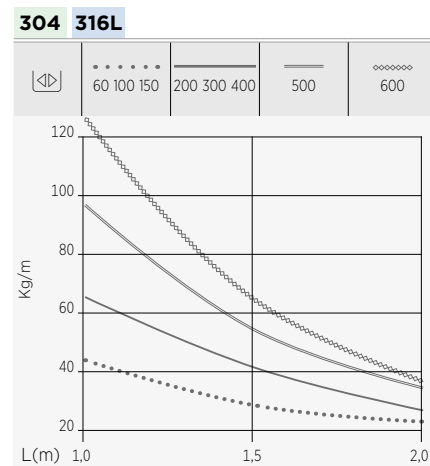
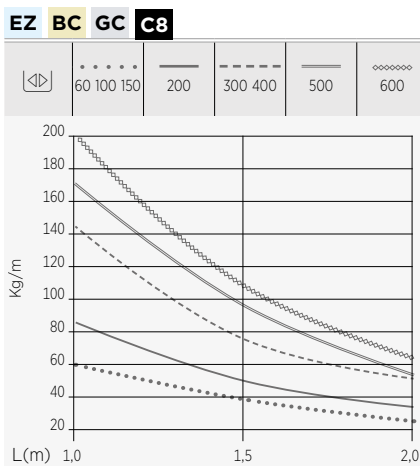

⊕	⊖	mm ²	∅ EZ, BC, GC, EP, C8	∅ 304, 316L
100	100	7.462	4,5	4,5
	150	11.562	4,5	4,5
	200	16.290	5,0	4,5
	300	25.290	5,0	4,5
	400	34.290	5,0	4,5
	500	43.290	5,0	4,5
600	52.290	5,0	4,5	

